

INCLUS / INCLUDED

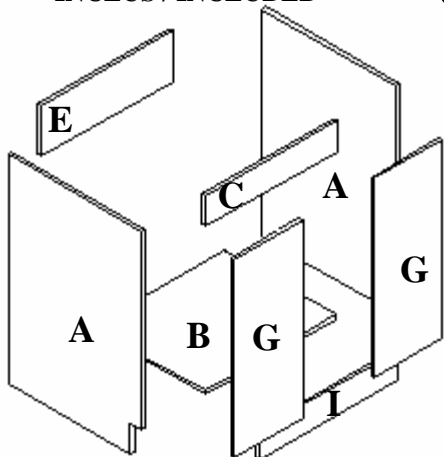

- A- Panneaux de cotés / Side panels
- B- Fond / Bottom
- C- Traverse avant-haute / Upper-front cross piece
- E- Traverse de dos / Back cross piece
- G- Portes / Doors
- I- Coup de pied / Kick step
- J- Sac de quincaillerie / Hardware bag

# Collection Renaissance

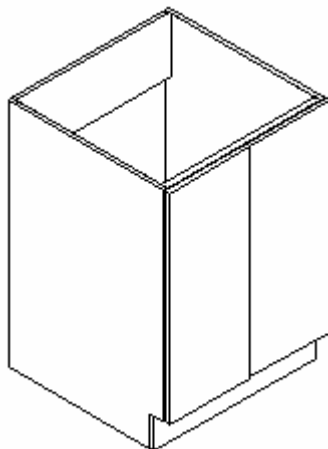

## Instructions d'assemblage Assembly instructions

2 PORTES / 2 DOORS

RV24 - RV30 - RV36

### QUINCAILLERIE / HARDWARE

CODE	ITEMS	DESCRIPTION	CAISSON
			RV24, RV30 et RV36
(bb)		Ferrure d'assemblage Cam lock	14
(cc)		Goujons de bois Wooden dowel	{6}
(ee)		Penture et plaque Hinge set	4
(ff)		Caoutchouc d'espacement Self-stick bumper	4
(nn)		Poignée Handle	2
(jj)		Vis 8-32 pour poignée 8-32 screw for handle	2

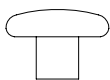
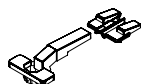

Assemblage facile et rapide / quick and easy assembly

1

Penture et Porte  
Hinge and Door

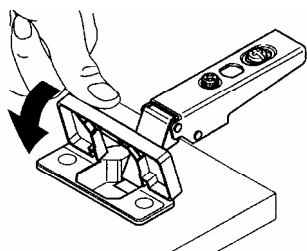

2

Penture et Plaque  
Hinge and Backer

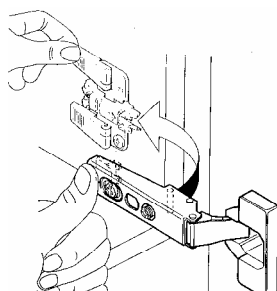

3

Serrer la ferrure d'assemblage à la douille  
Tighten cam to lock dowel

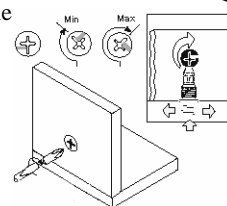
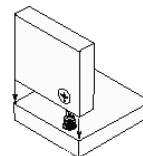
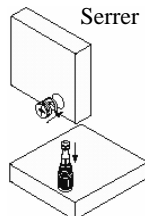

### AJUSTEMENT / ADJUSTEMENT

En hauteur / Height

En largeur / Width

En profondeur / Depth

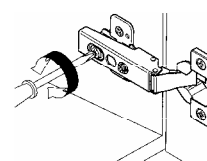
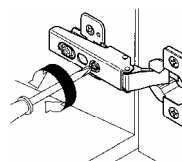
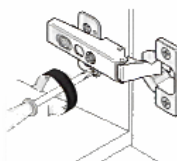

## Etape 1 Step 1

Placer un panneau de côté (A) sur une surface plane, y assembler les panneaux (B), (C) et (E) avec les ferrures d'assemblage (bb) dans les trous pré percés, ensuite serrer-les ensemble tel qu'illustré au dos.

Place side panel (A) on a flat surface, assemble panels (B), (C) and (E) to it with the CAM locks into the pre-drilled holes. After, tighten them together like the illustration on back.

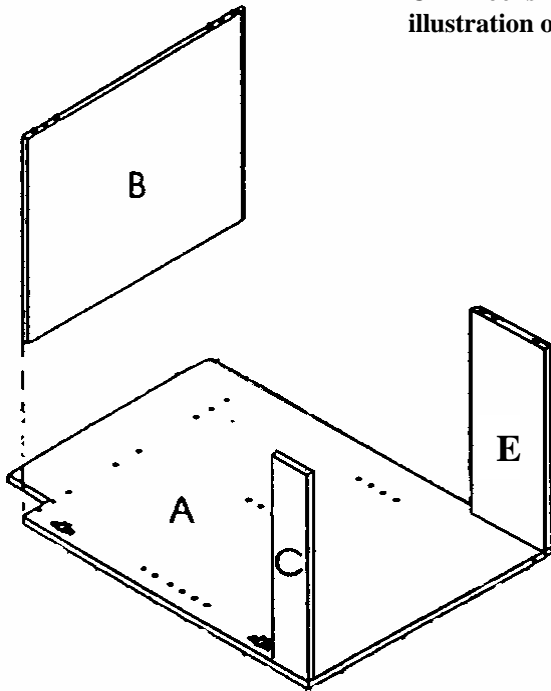

## Etape 2 Step 2

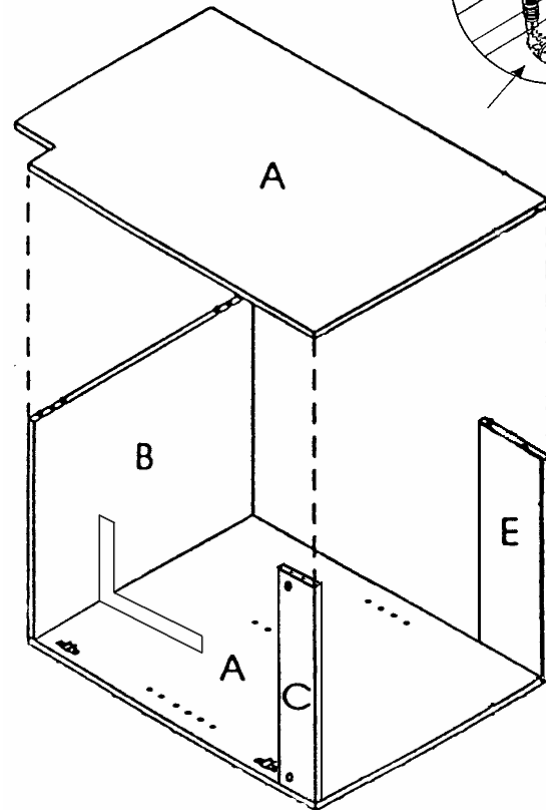

Placer l'autre côté (A) de façon à ce que les ferrures d'assemblage (bb) et les goujons de bois (cc) entrent dans les trous pré-percés à cet effet. Assurez-vous que le panneau (B) est d'équerre avec le panneau (A) pour garder le caisson bien droit.

Place the other side panel (A) so that the cam locks (bb) and wooden dowels (cc) fit in the pre-drilled holes. Make sure that (B) is square with panel (A) to keep cabinet straight.

## Etape 3 Step 3

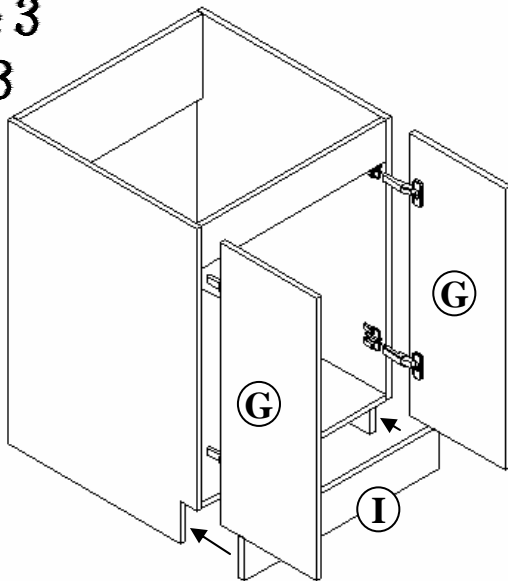

Fixer les portes (G) avec les pentures (ee) tel qu'illustré au verso. Coller les caoutchoucs d'espacement (ff) sur les coins intérieurs des portes. Assembler le coup de pied (I) aux côtés (A) avec les ferrures d'assemblage (bb) dans les trous pré-percés à cet effet.

Assemble doors (G) as illustrated on back with hinges (ee). Apply self-stick bumpers (ff) on the inner corners of the doors. Install kick plate (I) to sides (A) with the cam locks (bb) in the pre-drilled holes.